

Agriframes™

SUPERIOR FRUIT CAGE

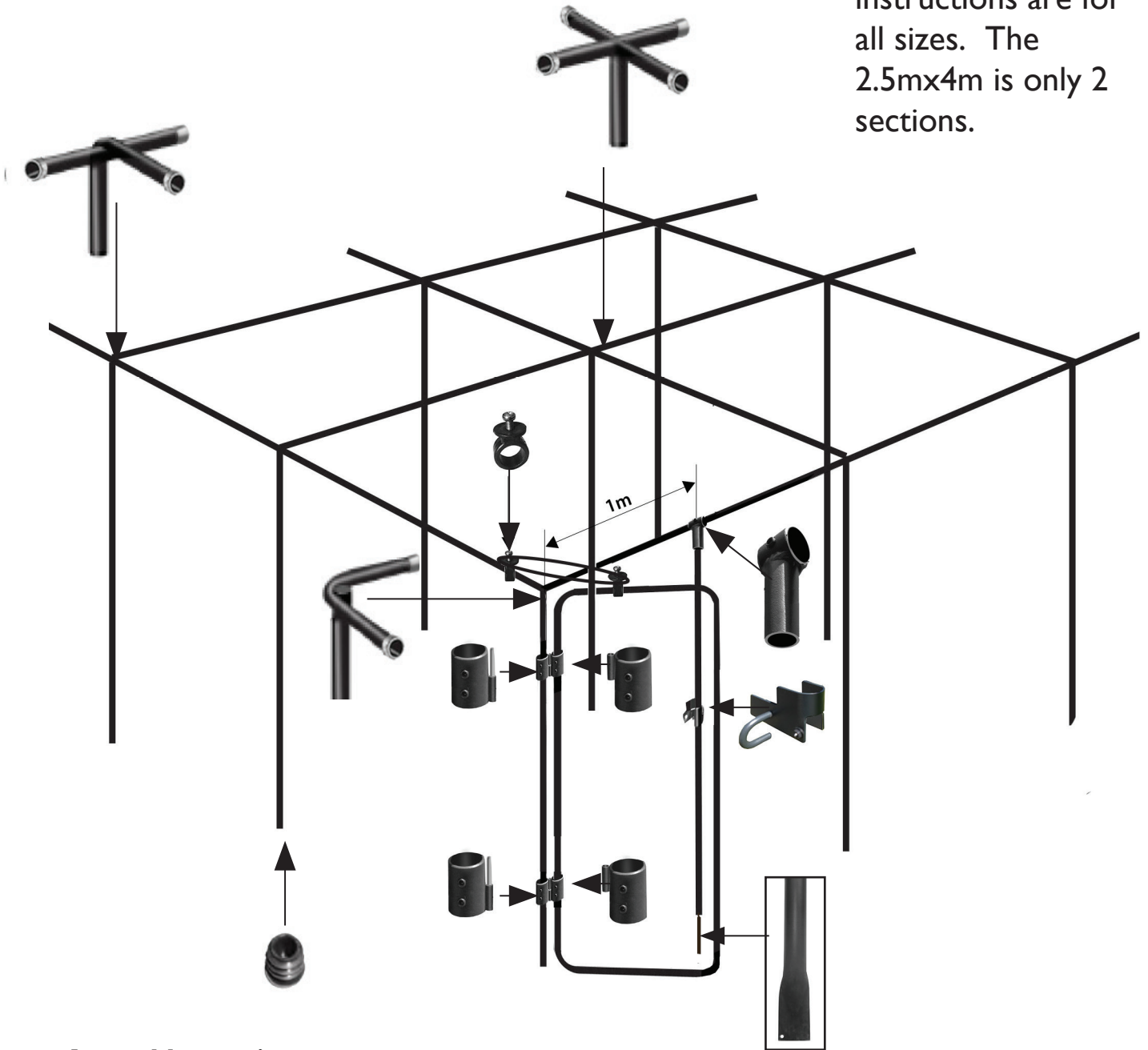



Please Note: These instructions are for all sizes. The 2.5mx4m is only 2 sections.



Assembly requires

Rubber Mallet, an Allen Key
(Provided) a Philips head Screwdriver,
Spirit Level,
Scissors and Tape Measure.

LAYOUT TEMPLATES

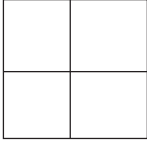
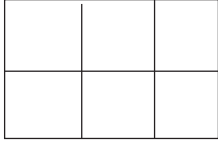
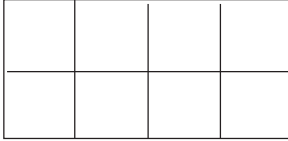
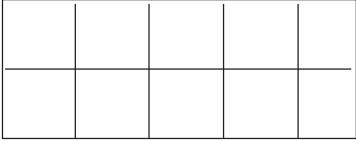
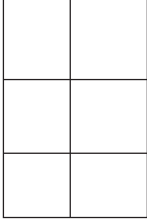
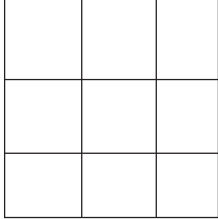
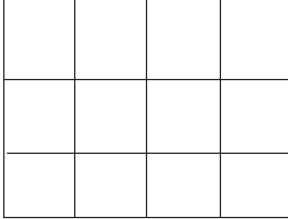
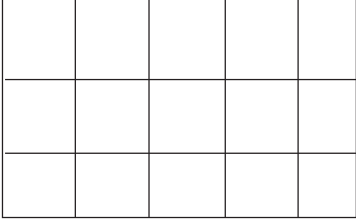
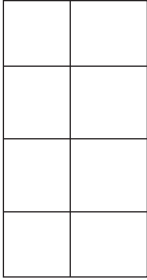
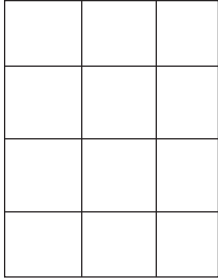
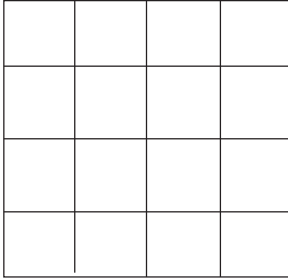
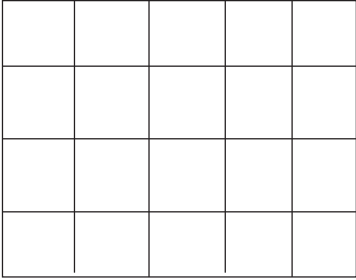
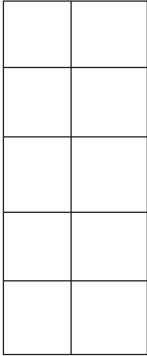
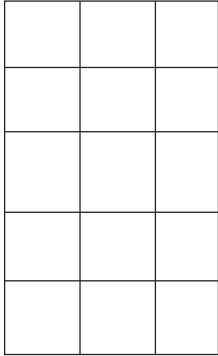
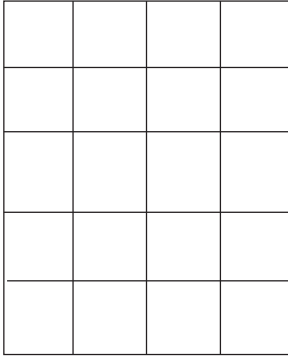
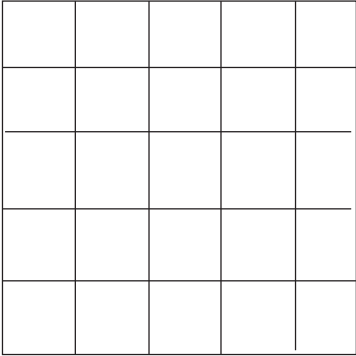
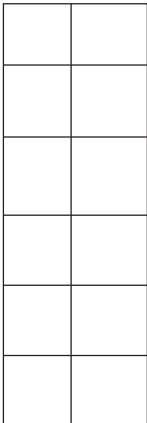
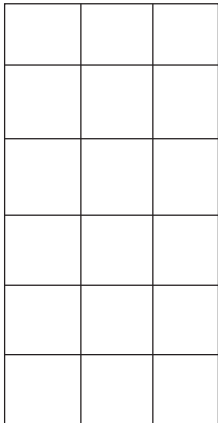
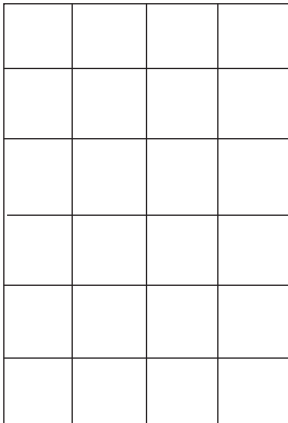
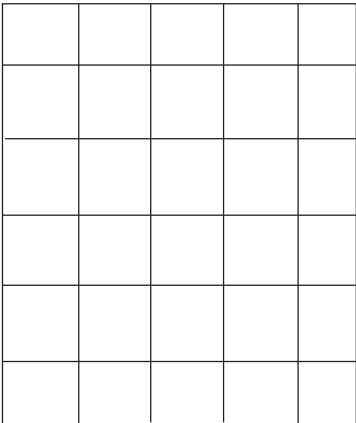
	5m	7.5m	10m	12.5m
2.5m				
5m				
7.5m				
10m				
12.5				
15m				

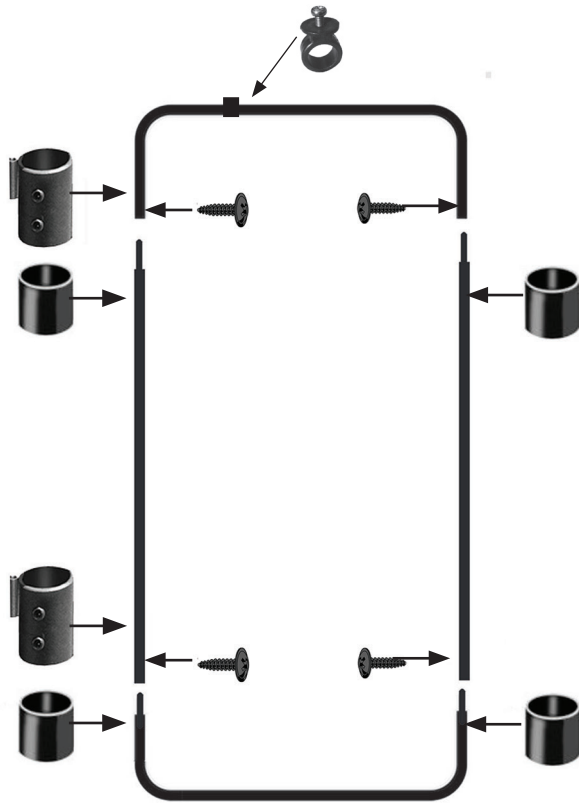

1. Lay the door frame parts out. Thread 2 moisture seals below the joins on either side of the door. Thread door hinges above the joins on one side.

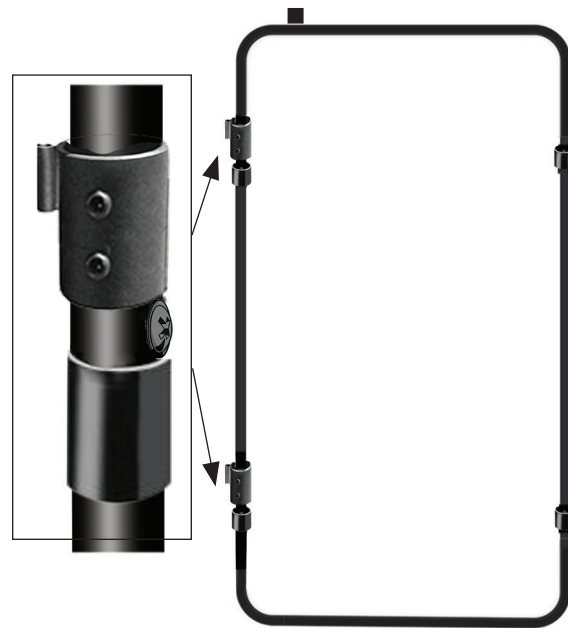

3. Join up the door frame and secure with self tapping screws. Move moisture seals up to cover tube joins

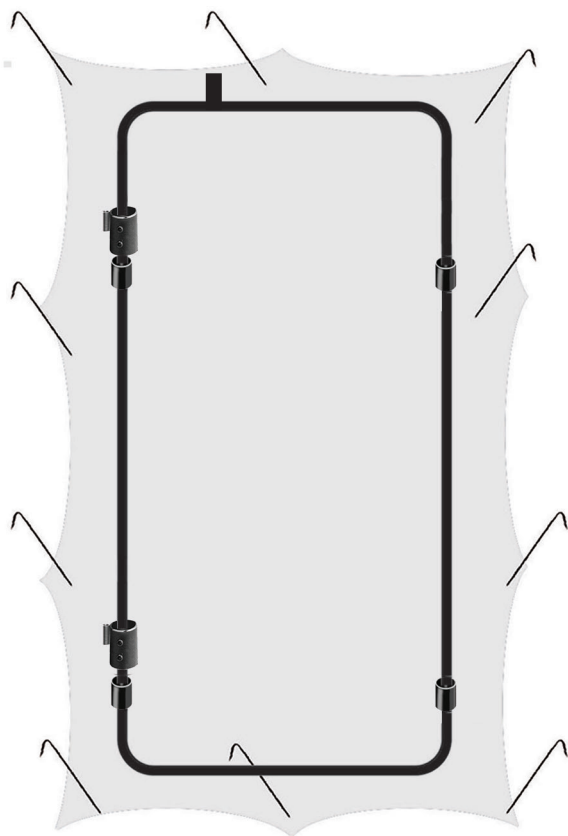

2. Cut out a section of the side net just larger than the door and stretch out with ground pegs.



4. As you remove the ground pegs trim the net leaving just enough to fold the excess net over the frame. Attach with S Hooks. Complete the process and then put the door to one side.

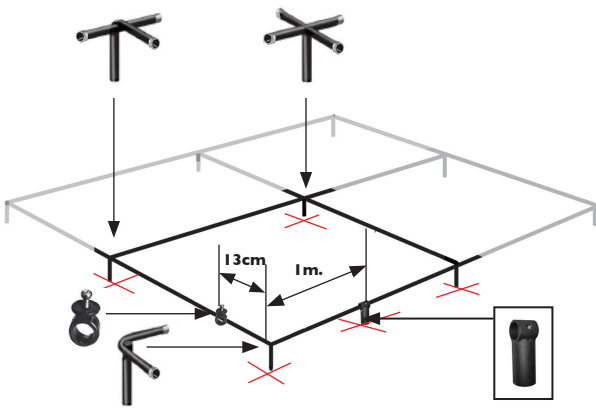

5. Pass a crossbar through a door collar and a second cross bar through the metal T joint.
Join the roof bars together with 3-way, 4-way and 5-way joints. Use the completed roof structure as a template to mark where the uprights have to go, including the door upright.

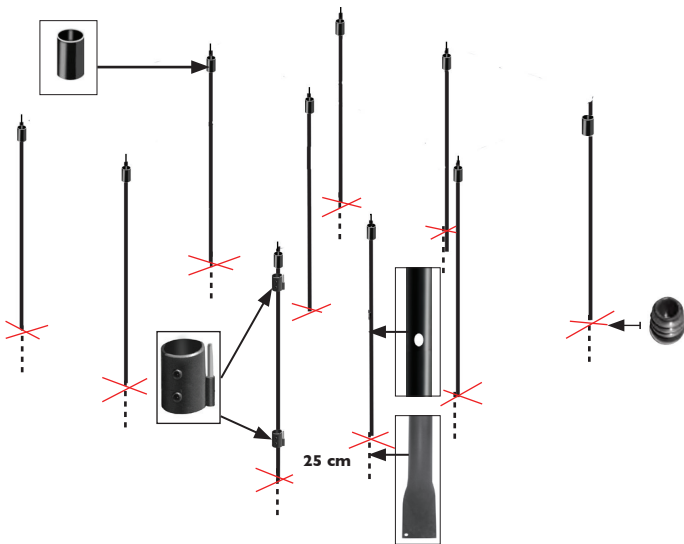

6. Drive a hole to the depth marked on the hole-maker which is approx. 38cm – the easiest way to do this is by placing a small plank of wood over the top of the hole-maker and using a rubber mallet to hit into the ground. Insert an end plug into the base of each upright and a moisture seal at the top. Push the uprights into the ground. Make sure the pre-drill hole, on the door catch upright, is at right angles to the frame.

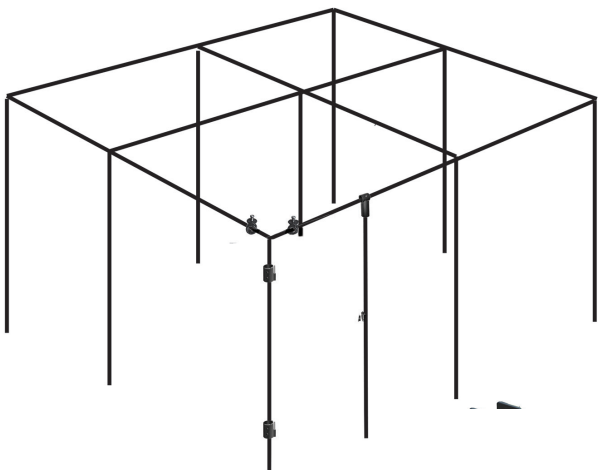

7. Place the roof on top of the uprights. Push all the moisture seals over the joints

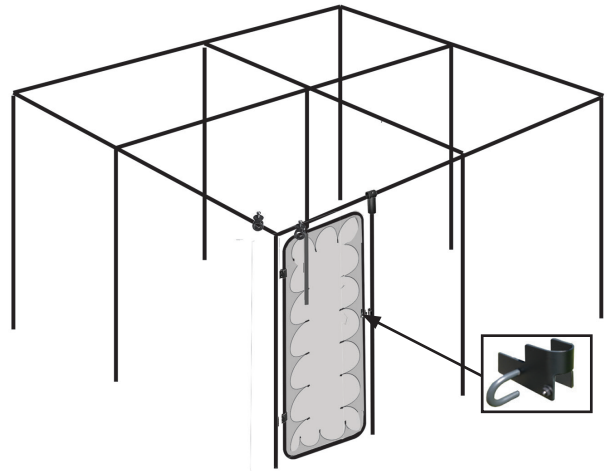



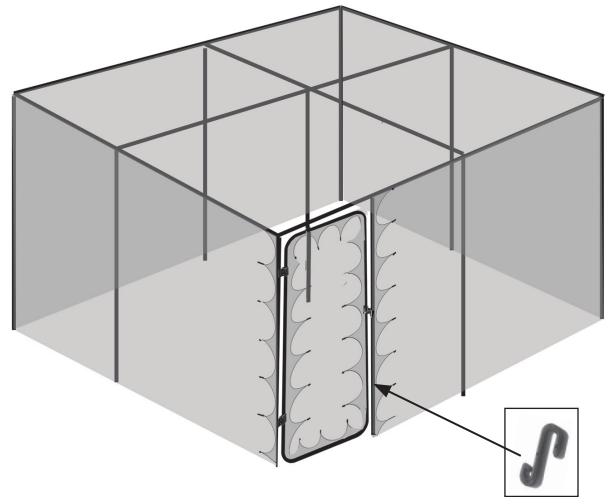



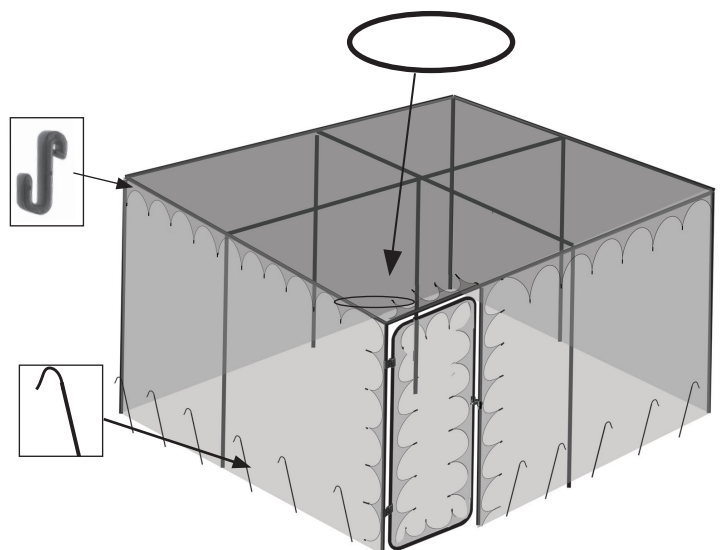



8. Drop the completed door onto the hinged on the door upright. Adjust hinges on the upright as required.













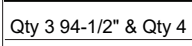



9. Attach the side net to the perimeter cross bars with cable ties and to the door uprights with 'S' Hooks.



10. Attach roof net over the roof using S Hooks. Secure the side net to the ground with ground hooks. place the band on the band collars.

DOOR PARTS			
CODE	PART	No	
 AGR-A610/40	3/4" MOISTURE SEAL	4	
 AGR-A70/006	3MM ALLEN KEY	1	
 AGR-CATCH/003-TBK AGR-CATCH/002-GLV	DOOR CATCH	1	
 AGR-T-JOINT001	3/4X3/4 METAL T-JOINT	1	
 AGR-DOORHINGE/01	DOOR HINGE SETS	2	
 AGR-BAND-001	DOOR BAND	1	
 AGR-COLLAR/001-TBK	DOOR COLLAR	2	
 AGR-A73/006	M6 x 16 SCREW (Screw already inserted in collar)	2	
	DOOR FRAME 71410-GLV 71610-TBK		
	Door top with plain ends and pre-drilled hole	1	
	Door Uprights with reduced ends	2	
	Door Bottom with reduced ends and pre-drilled hole	1	
 AGR-A73/009	SELF TAPPING SCREW (included with frame)	4	
	71611-TBK 71411-GLV	1	
	Door catch upright 22mm x 2.3m with flattened end and pre-drilled hole.		

MISSING PARTS PROCEDURE, please call our customer service team on 0117 934 1790 and quote your order reference and the code for your missing part. If no code just quote the part Eg. 2.4m Roof bar with plain end.

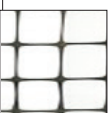
FRAME PARTS		
CODE	PART	
 71601-TBK	CROSS POLES	
 71401-GLV	19mm X 2.4m Plain end	
	Qty 3 94-1/2" & Qty 4 74-3/4"	
 71600-TBK	UPRIGHTS	
 71400-GLV	22mm X 2.3m reduced end	
	Qty 6	
 71521-TBK	HOLEMAKER	
 71603-TBK	3-WAY JOINT	
 71403-GLV		
 71604-TBK	4-WAY JOINT	
 71404-GLV		
 71605-TBK	5-WAY JOINT	
 71405-GLV		
 AGR-A610/16-TBK	END PLUG 20mm	
NET PARTS		
 AGR-A70/002-TBK	CABLE TIES	
 AGR-F/C-GROUND-HOOK	GROUND HOOKS	
 AGR-A610/31	S HOOKS	
 7400	ROOF NET	
 74200	SIDE NET	

Issues:

If you are experiencing any issues with your Agriframes product please contact our customer services team on 0117 934 1790 and quote your order reference.

WARNING, Contains small parts, tools and plastic bags. Keep children away until the unit is assembled and everything is cleared away.

NOTE the card, paper sack, and polythene bags are recyclable - please dispose of carefully.

Agriframes™

AGRIFRAMES, Journal House, Hartcliffe Way, Bristol, BS3 5RJ

ORDERS (0) 117 934 1790 FAX + (0) 117 934 1791 ORDER ONLINE www.agriframes.co.uk