









# Agriframes

**Product code:** 40522-TBK  
**Description:** Classic Extra Gothic Gazebo Matt Black 3.6m

Quantity	Component
8	84 "Uprights with One Reduced End
8	Gothic Curves
1	3 x 128" Large Top Ring in several pieces
1	3 x 115 ¼" Medium Top ring in several pieces
1	2 x 52 ½" Small Top ring in several pieces
8	23" Spacer Bars with Ring Clamps
1	Hole Maker
Quantity	Optional Component
8	Lattice Panels (5 x 4)
8	Ground Pegs
64	Cable Ties

Code	Description	Drawings	Quantity
AGR-A73/002	Spare Grub screws (in a separate bag)		1 Bag
AGR-A610/34M	1" x 7/8" Metal 2 way joint.		12
AGR-A610/41	7/8" Moisture Seal		8
AGR-A610/38	1" Moisture Seal		8
AGR-A610/08	1" End Plug		8
AGR-70/012 AGR-A70/006	4mm Allen Key & 3mm Allen Key		1
AGR-A602/03	10 x 4" Wooden Finial		1
AGR-MISC-002	Brass Top Clamp Assembly with M8 Grub screws		1

**Issues:**

If you are experiencing any issues with your Agriframes product please contact our customer services team on 0117 934 1790 and quote your order reference.

**WARNING:** Contains small parts, tools and plastic bags. Keep children away until the unit is assembled and everything is cleared away.

**NOTE:** The card, paper sack, and polythene bags are recyclable - please dispose of carefully.

**MISSING PARTS PROCEDURE:** Please call our customer service team on 0117 934 1790 and quote your order reference and quote the missing part. *E.g. ASO-----, 2 uprights missing.*

# Assembly Instructions Classic Extra Gothic Gazebo Matt Black 3.6m

Product code: 40522-TBK

Please read these instructions carefully.

**Assembly requires:** A Rubber Mallet, an Allen Key (provided), a Ladder, a Spirit Level, Pliers, a Tape Measure and at least 2 people.

Please read the assembly instructions carefully prior to construction.

## Tips:

Before positioning the Spacer Bars on the uprights, half screw in the grub screws to the Ring Clamps on the Spacer Bars, to reduce the risk of losing the screws.

Once correctly positioned tighten the grub screw to secure the spacer bar to the uprights.

## Positioning of the Spacer Bars

In many cases the position of the horizontal bars is down to personal preference. However, if you have the lattice option you will need to leave the correct distance between bars.

## Lattice Panel Option

For illustrative purposes we have only shown one side fixed with the lattice panels. Attach panels to both sides as you proceed.

1. Before assembly check Spacer Bars to ensure the grub screws are inserted into the holes on the ring clamps.
  - Loosen these grub screws  $\frac{1}{2}$  way out of the hole, to ensure when the ring clamps are moved into position the grub screw does not scratch the outer coating of the metal.

## **Assemble the Top of the Gazebo...**

2. Referring to Figure 1, slide the top of the Gothic Curves into the brass top clamp assembly. Tighten the grub screws so that they hold onto the tubes, these may have to be readjusted later.
3. Slide a 2-Way connector onto 4 alternate Gothic Curves. Attach 2 x 2-Way Connectors onto each of the remaining Gothic Curves, as demonstrated in Figure 2.
4. Temporarily attach a Spacer bar to each set of curves, partially tighten the grub screws, this will allow you to check the spacing of the gothic curves, they will be moved later.
5. Adjust the position of the Gothic Curves, as required from the previous step. Tighten the grub screws in the Brass Top Clamp Assembly to secure the Gothic Curves.
6. Insert the Gothic Finial into the Top Clamp Assembly.



Figure 1: Attach Gothic curves to the Brass Top Clamp Assembly

## **Attach the Top Rings to the Gothic Curves...**

7. Slide a moisture seal over the reduced end of the Large, Medium and Small Top ring pieces.
8. Referring to Figure 2, push the medium top ring pieces through the 2-Way connectors on alternate Gothic Curves, ensure that the rings are on the outside of the Gothic Curves. Do not tighten the connectors.

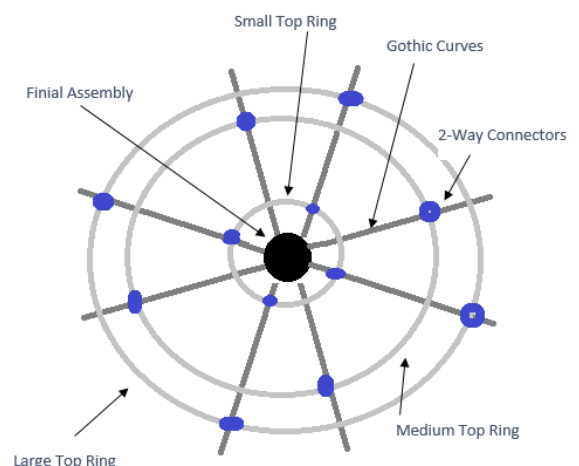

Figure 2: Attach the Top Rings

9. Join the Medium Top Ring pieces together, covering the join between the Top Ring pieces with a moisture seal.
10. Repeat this process for the Large and Small Top Rings.
11. Ensure that the Top Rings are level and concentric to the Gazebo Top, once satisfied with the position of the rings, tighten the connectors.

#### Move the Top section to the intended location...

12. Move the Gazebo top to where the structure will be installed, ensure that the 4 pairs of legs are positioned equidistance apart.
13. Once satisfied with the position of the curves, firmly push the structure into the ground to make an impression or mark in the soil. These impressions indicate where the uprights need to be inserted.
14. Remove the Gazebo top, using the Hole Maker create holes 15" deep, where you have marked the ground. Ensure the holes are vertical and to the same depth.

#### Insert the Uprights...

15. Tap an end plug into the non-reduced end of the 84" uprights.
16. Insert an upright into the holes, ensure that the uprights stand vertical and are level to one another.
17. Attach 2 spacer bars to each of the uprights, position the spacer bar as per Figure 3.

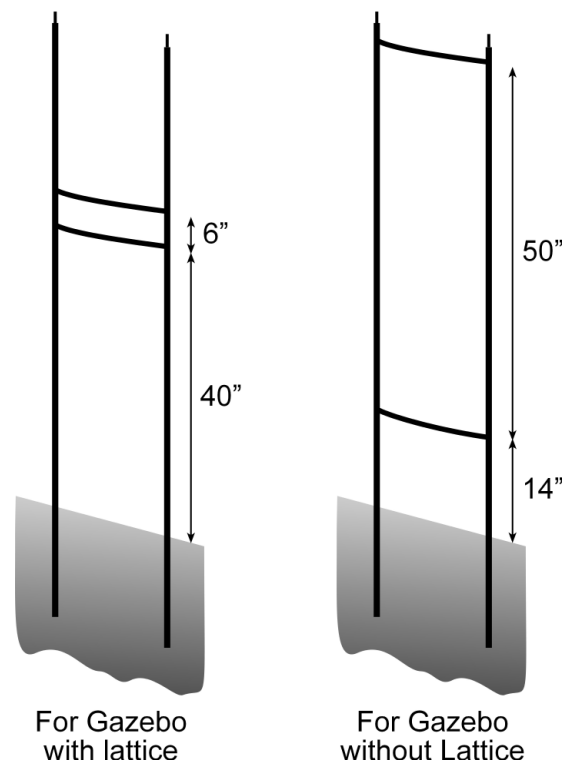

Figure 3: Position the Spacer Bars on the Uprights

18. Slide a moisture seal onto the reduced end of the upright.

#### Lift the Top of the Gazebo onto the uprights...

19. Lift the constructed Gazebo Top onto the uprights, ensure that the Gazebo Top is lowered evenly onto the uprights.
20. Cover the Joins with moisture seals.

#### Final checks...

21. Check that all of the joins have been covered by moisture seals.

22. Ensure that all of the connectors have been tightened and are fully secured.

**Optional Component: Fixing the Bottom Lattice Section...**

23. Secure the 4 lattice panels between the large top ring and the top spacer bars on the top section of the Gazebo, using the lattice ties.
24. Secure the remaining lattice panels to the lower spacer bars using the lattice ties, then attach the lattice panel to the ground using the ground hooks.
  - Ensure that the panels are centred within each bay.
  - Please Note: you may need to slightly bend the lattice panel to form a curve in the line.
25. Trim the ends of the lattice ties.

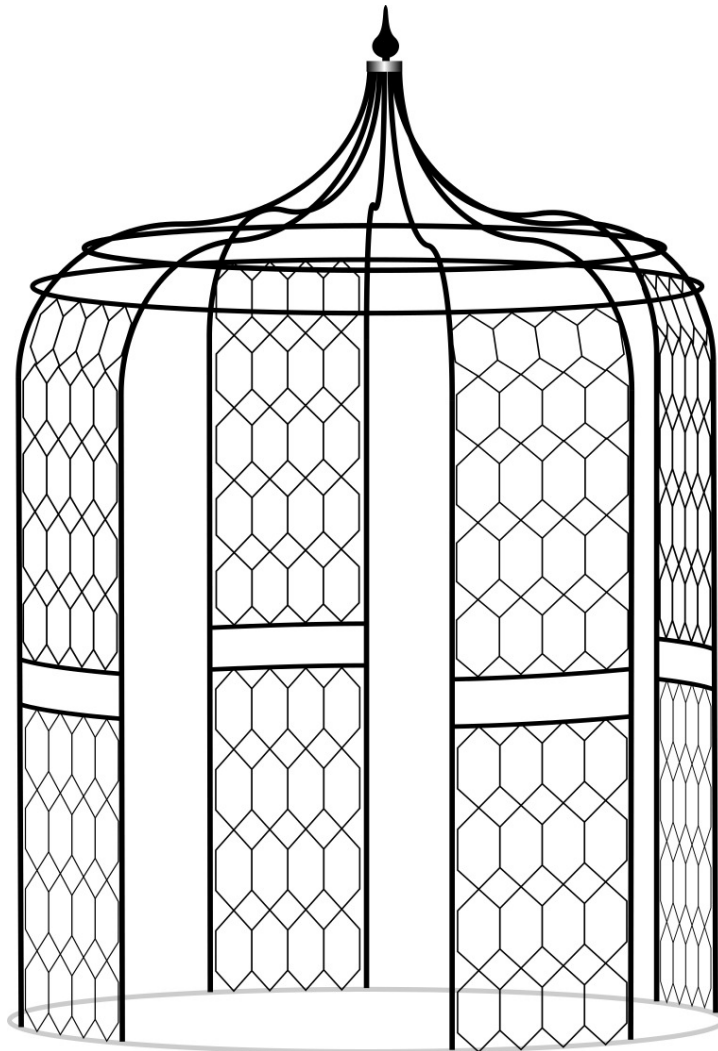

**If you have any questions regarding assembly please call our customer service team on 0117 934 1790**